

CE 0197 ISO 13485

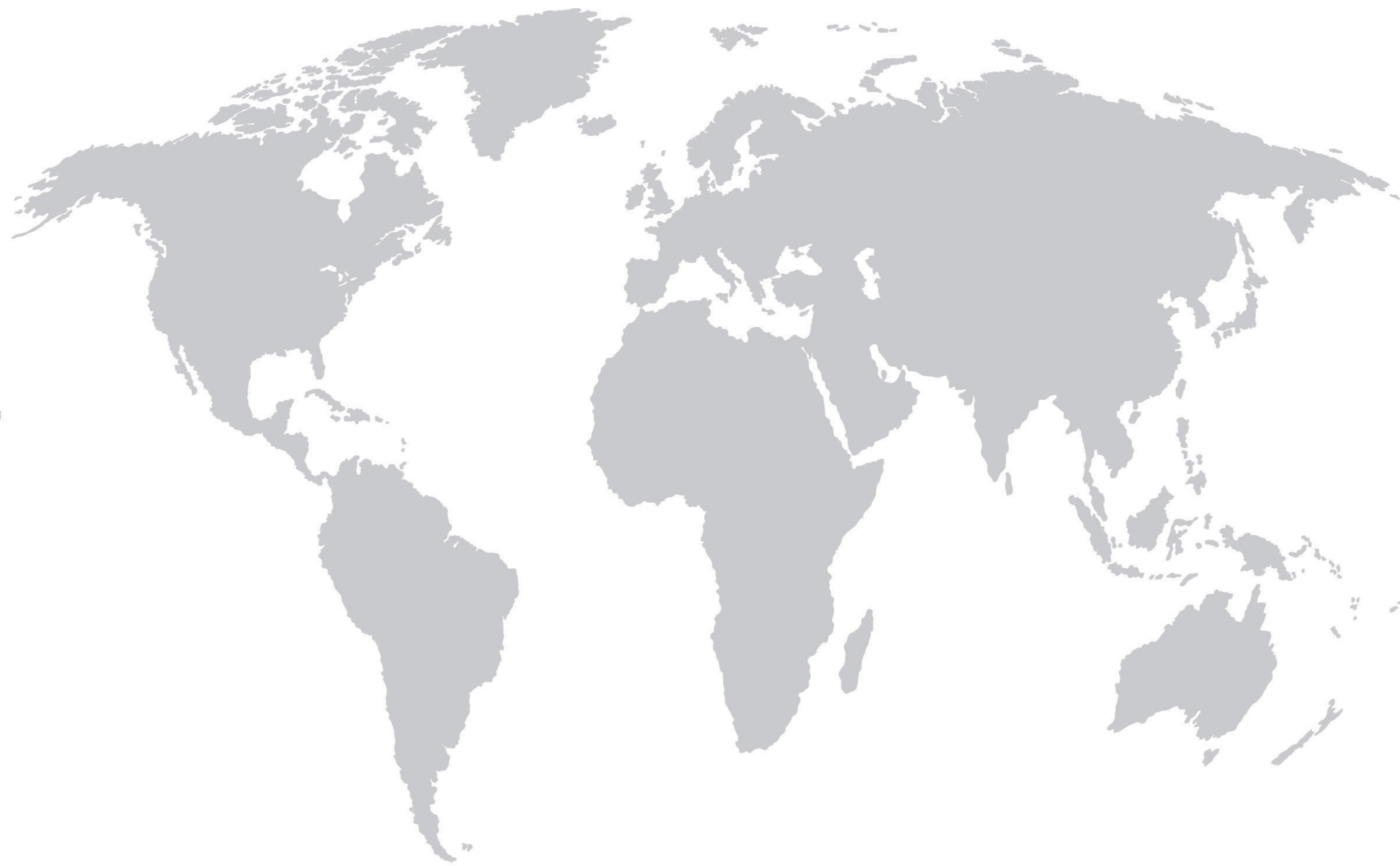

Huaian Helen Medical Instrument Co.,Ltd.

Tel/Fax : (86) 0517-84266088

Cel : (86) 158-9616-0787

E-mail : 446160132@qq.com; hahlmy@163.com

P.c : 223345

Web : www.medhl.com; www.hahlmy.com

Address: Group 3, Zhengtai Village, Matou Town,
Huaiyin District, Huaian, Jiangsu, China



Scan the QR Code for website



淮安市海伦医疗器械有限公司
Huaian Helen Medical Instrument Co.,Ltd.



公司简介

淮安市海伦医疗器械有限公司成立于2012年6月，注册资金：130万元，是一家生产出口一次性采血针、手术刀片、酒精棉片、一次性引流袋等产品的源头厂家。公司拥有900平方米的洁净车间，各项产品检测仪器，具有20多名团队精英的经营队伍，公司目前以良好的市场口碑和严格的内部管理，得到了ISO:13485医疗器械质量体系认证和CE0197认证。

公司座落于历史悠久的淮安千年古镇马头镇。我们的产品销往东南亚、中东、非洲、欧洲等地区。近年海伦医疗在“生产过程中对客户负责，交货后让客户满意”的企业经营理念下，持续采用和推广新工艺、新技术、新材料、新构思、新理念，不断加大开发新产品，改良老产品的生产工艺，以坦诚的合作态度、良好的信誉和优良的产品，竭尽全力为全球客户提供满意的服务，为自身创造更大的价值，为社会创造更多的财富。

——以质量求生存 以诚信求发展——

Company Profile

Huaian Helen Medical Instrument Co.,Ltd. was founded in June 2012. With a registered capital of 1.3 million yuan, the company is a source manufacturer and exporter of Disposable Blood Lancet, Surgical Blades, Alcohol Pad, Urine Bags etc. There is a 900m² clean workshop, various product testing instruments and with more than 20 team elites. The company has obtained ISO 13485 and CE 0197 for its good market reputation and strict internal management.

The company is located in Matou Town, a thousand-year-old historic town in Huaian, Jiangsu, China. Our products are sold to Southeast Asia, the Middle East, Africa, Europe and other regions. Under the business philosophy, which is “RESPONSIBLE FOR THE PRODUCT DURING THE PRODUCTION PROCESS, AND MAKE THE CLIENTS SATISFIED AFTER DELIVERY” , our company constantly adopts new techniques, technology, materials, ideas and concepts to develop new products and improve old ones. With a frank attitude of cooperation, good reputation and excellent products, we do our best to provide satisfied services for global customers, improve our own value and create more wealth for the society.



General Process

Certifications

Produce



Test



Packaging



Company Honors



Blood Lancet (Twist)

[Code No.] HL001

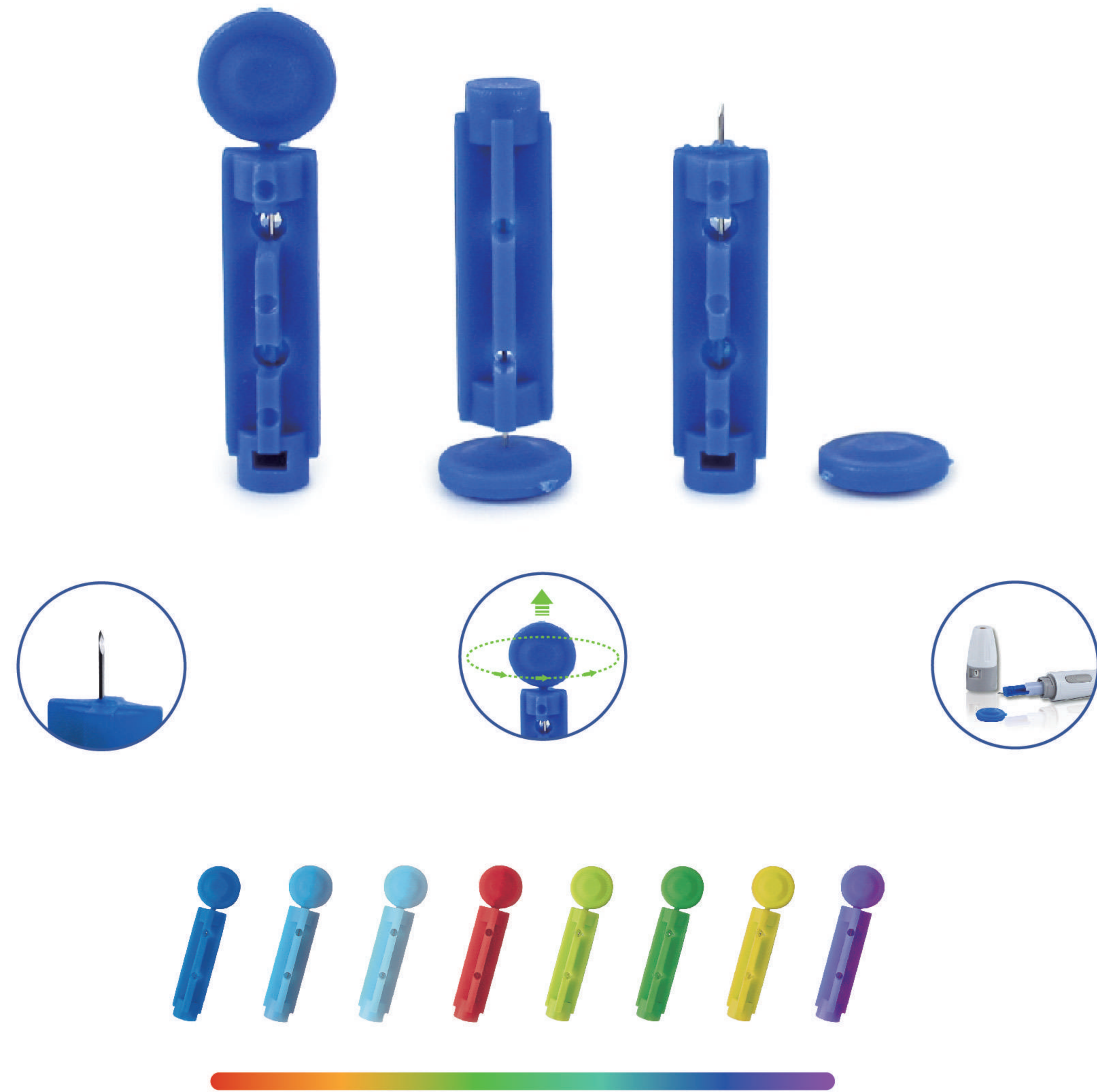

Multiple Colors Can Be Customized

Size	21G 23G 26G 28G 30G
Material	PE, Stainless Steel
Shelf Life	5 Years
Type of Sterilization	Gamma Radiation
Packing Specification	100 pcs/box, 200 boxes/ctn; 47.5cm x 34cm x33cm 200 pcs/box, 100 boxes/ctn; 40cm x 28cm x 37cm

Blood Lancet (Flat)

[Code No.] HL002

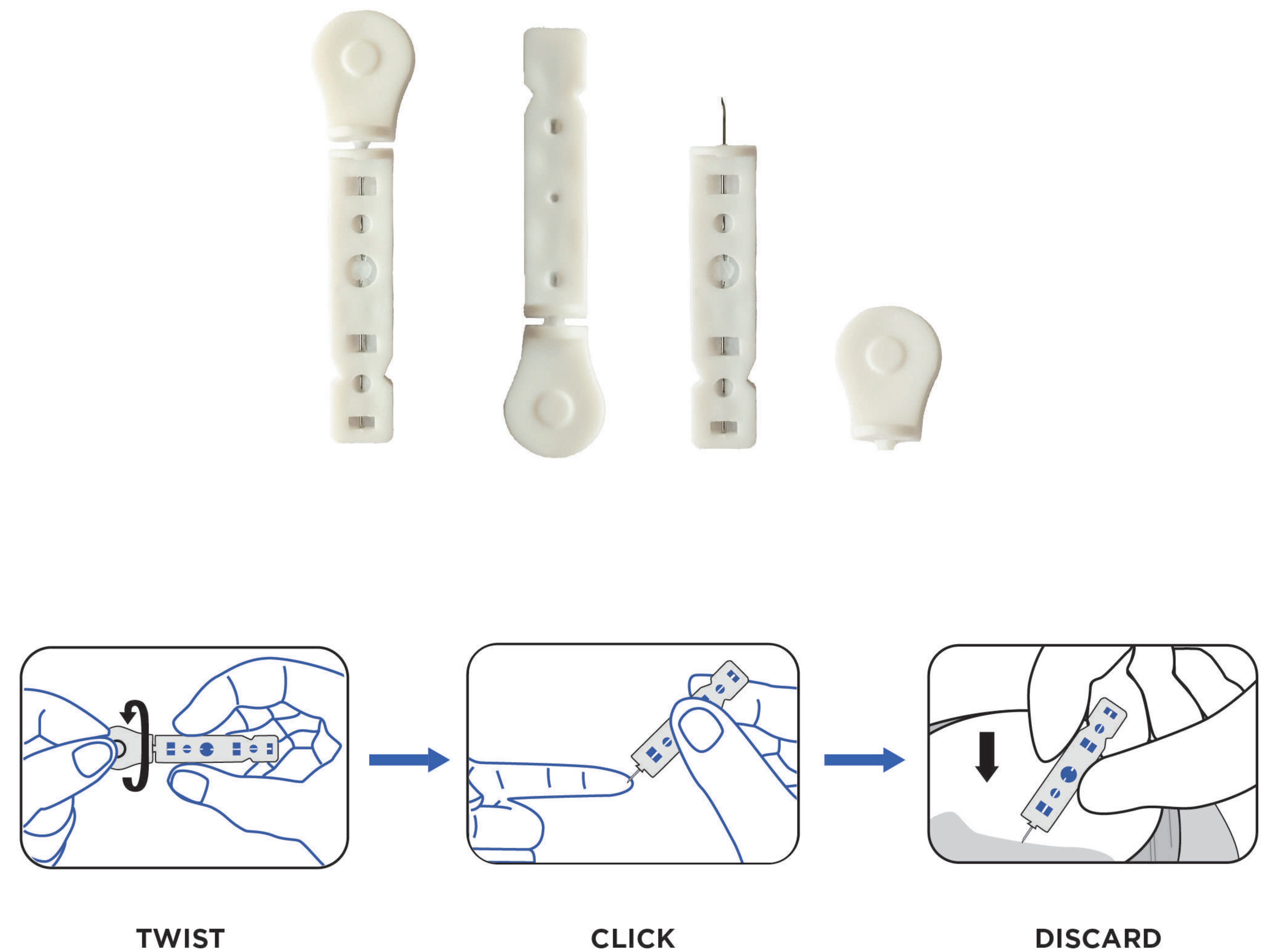

Size	28G 30G
Material	PE, Stainless Steel
Shelf Life	5 Years
Type of Sterilization	Gamma Radiation
Packing Specification	100 pcs/box, 200 boxes/ctn; 47.5cm x 34cm x33cm 200 pcs/box, 100 boxes/ctn; 40cm x 28cm x 37cm

BLOOD LANCET

BLOOD LANCET

Blood Lancet (Flake)

[Code No.] HL003

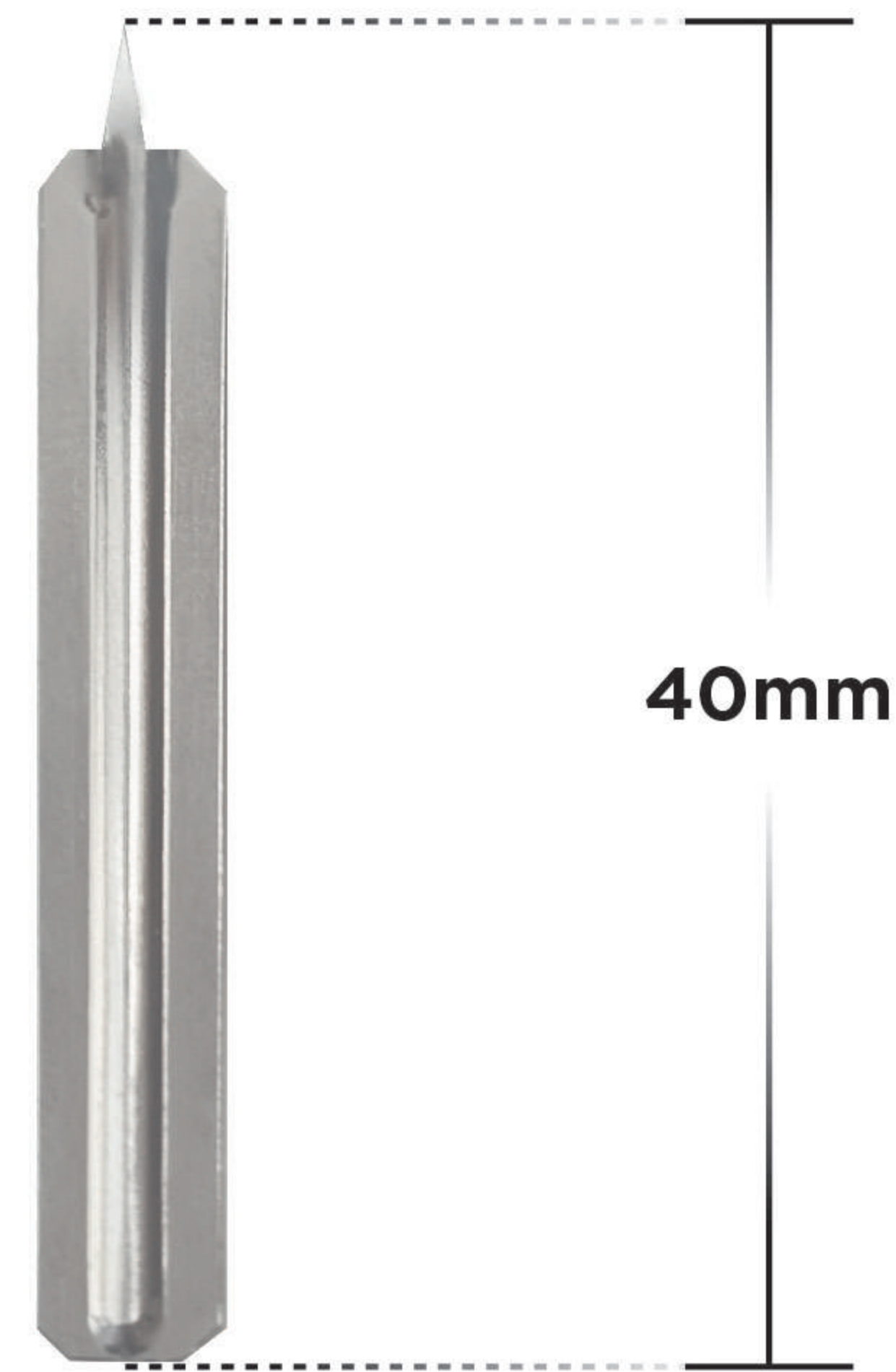

40mm

- Made of high quality medical grade stainless steel
- Smooth and sharp flake needle point to get puncture reducing patients' pain in maximum extent

Size	L Type
Material	Stainless Steel
Shelf Life	5 Years
Type of Sterilization	Gamma Radiation
Packing Specification	200 pcs/box, 100 boxes/ctn; 44cm x 33.5cm x 18cm

Lancing Device

[Code No.] HL004

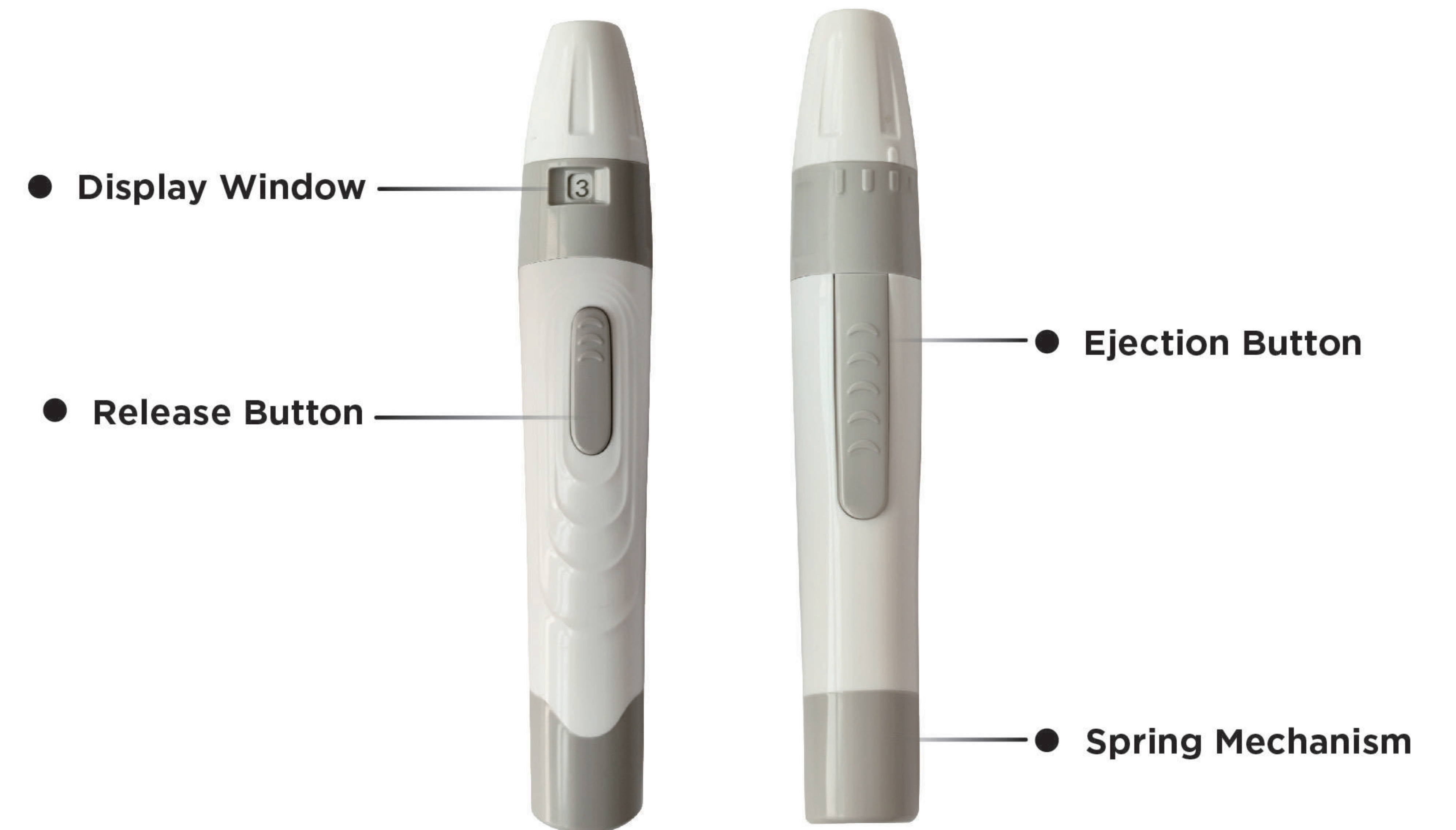

Adjustable Depth	5 Levels
Length	10.5cm
Material	ABS
Usable Times	± 3000 times
Packing Specification	1 pcs/box, 100 boxes/ctn; 27.5cm x 22cm x 22cm

BLOOD LANCET

LANCING DEVICE

Surgical Blade

[Code No.] HL005 HL006

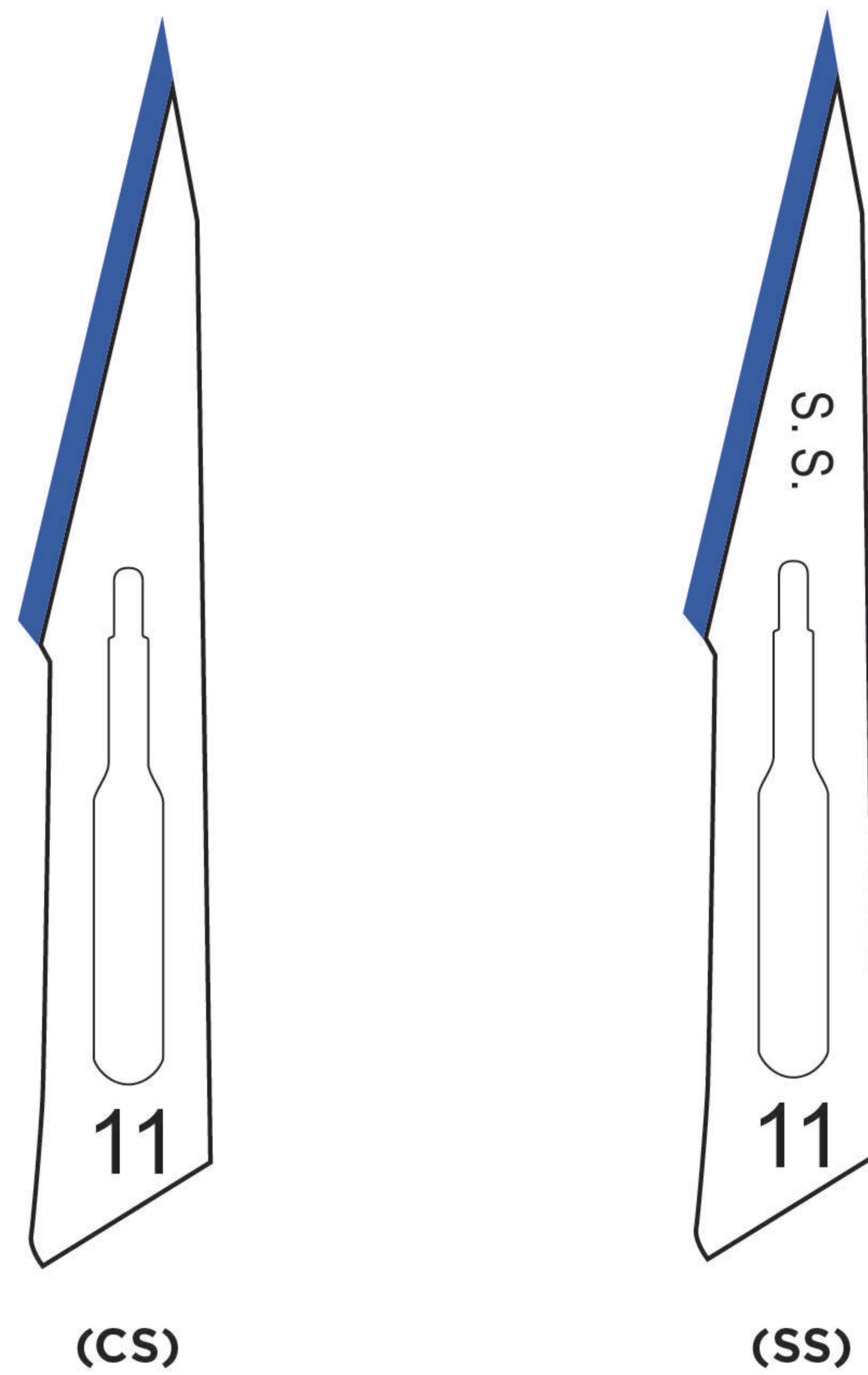

Regular Size

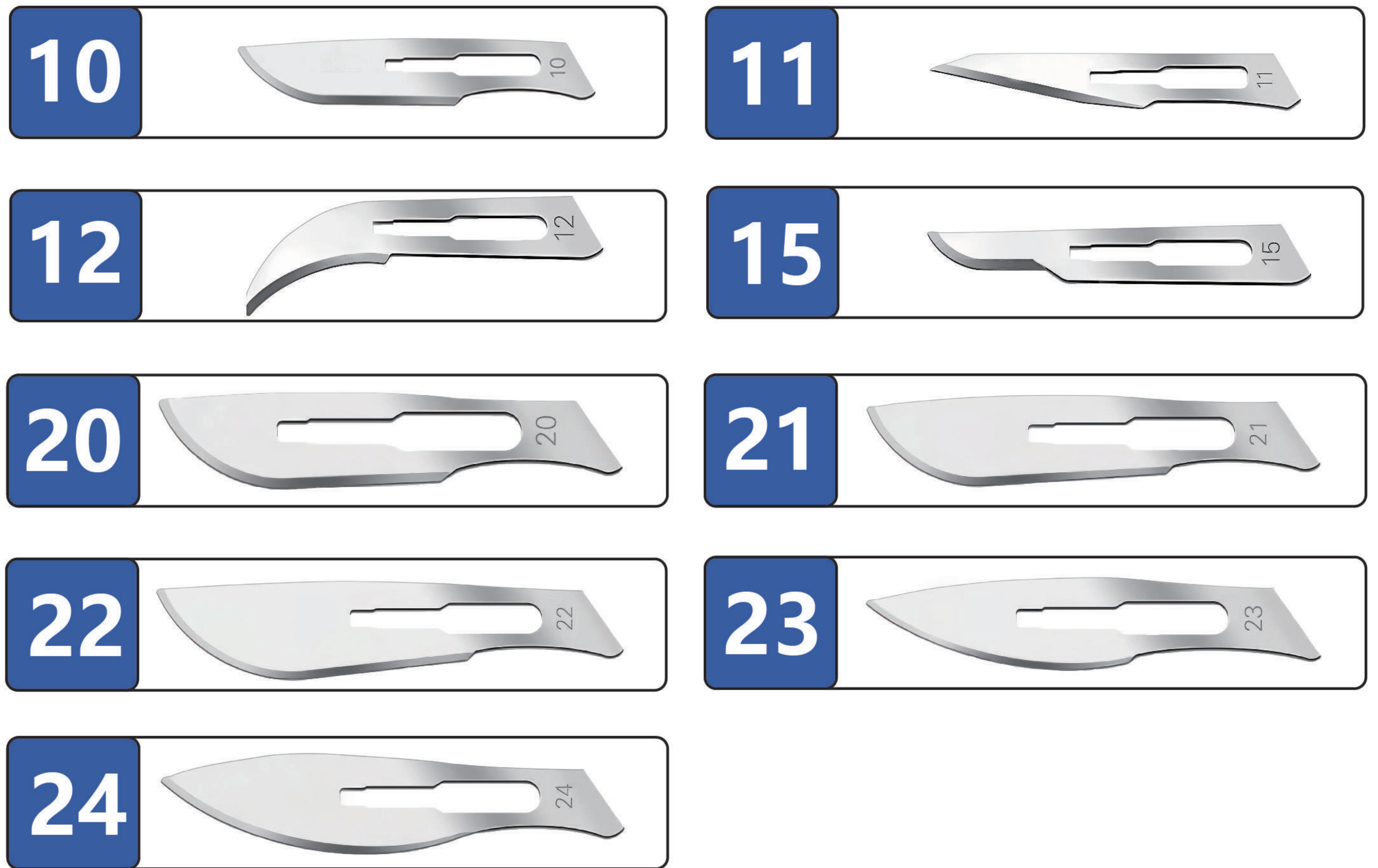

Other Size

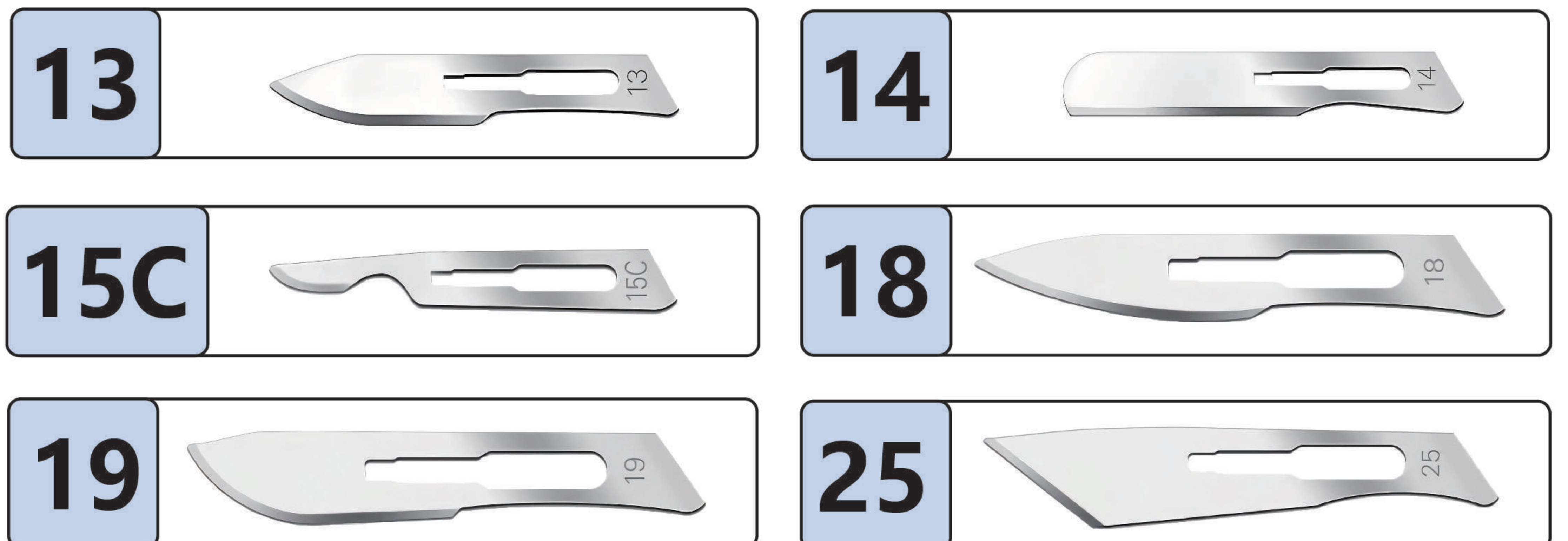

SURGICAL BLADE

SURGICAL BLADE

Size	10# 11# 12# 13# 14# 15# 15C# 18# 19# 20# 21# 22# 23# 24# 25#
Material	Carbon Steel (CS) or Stainless Steel (SS)
Shelf Life	5 Years
Type of Sterilization	Gamma Radiation
Packing Specification	100 pcs/box, 50 boxes/ctn 36cm x 20cm x 17cm, 36cm x 32cm x 10.5cm

Sterile Disposable Scalpel

[Code No.] HL007



Skin Graft Knife Blade

[Code No.] HL008



Medical Disposable Surgical Skin Graft Knife Blade

- Be used with handle
- Steriled
- For single use
- Individually packed
- For various surgeries like cosmetic, skin burn, skin ulcer ...
- Compatible with the majority of skin graft handles

Size	10# 11# 12# 13# 14# 15# 15C# 18# 19# 20# 21# 22# 23# 24# 25#
Material	Carbon Steel or Stainless Steel, PP
Shelf Life	5 Years
Type of Sterilization	Gamma Radiation
Packing Specification	10 pcs/box, 50 boxes/ctn; 42cm x 32cm x 22cm

Size	156mm x 19mm
Material	Carbon Steel or Stainless Steel
Shelf Life	5 Years
Type of Sterilization	Gamma Radiation
Packing Specification	50 pcs/box, 50 boxes/ctn; 42cm x 32cm x 21cm

STERILE DISPOSABLE SCALPEL

SKIN GRAFT KNIFE BLADE

Stitch Cutter Blade

[Code No.] HL009



Medical Disposable Surgical Stitch Cutter Blade



- Can be used without handle
- Steriled
- For single use
- Individually foiled packed
- For hygienic cutting and removal of wound sutures
- Long blade for a more aseptic technique

Size	112 mm
Material	Carbon Steel
Shelf Life	5 Years
Type of Sterilization	Gamma Radiation
Packing Specification	100 pcs/box, 50 boxes/ctn; 36cm x 20cm x 17cm

Alcohol Pad

[Code No.] HL010



- 30mm*60mm, compact and portable, easy to use
- High alcohol for quick disinfection
- Approved by multiple labs' chemical test reports

Effectively Clean Application



Size	3cm*6cm (unfolded)
Material	Alcohol + Water + Non-Woven Fabric
Shelf Life	5 Years
Packing Specification	100 pcs/box, 100 boxes/ctn; 42.5cm x 29.5cm x 29.5cm 200 pcs/box, 100 boxes/ctn; 54.5cm x 44cm x 30.5cm

STITCH CUTTER BLADE

ALCOHOL PAD

Urine Bag

[Code No.] HL011

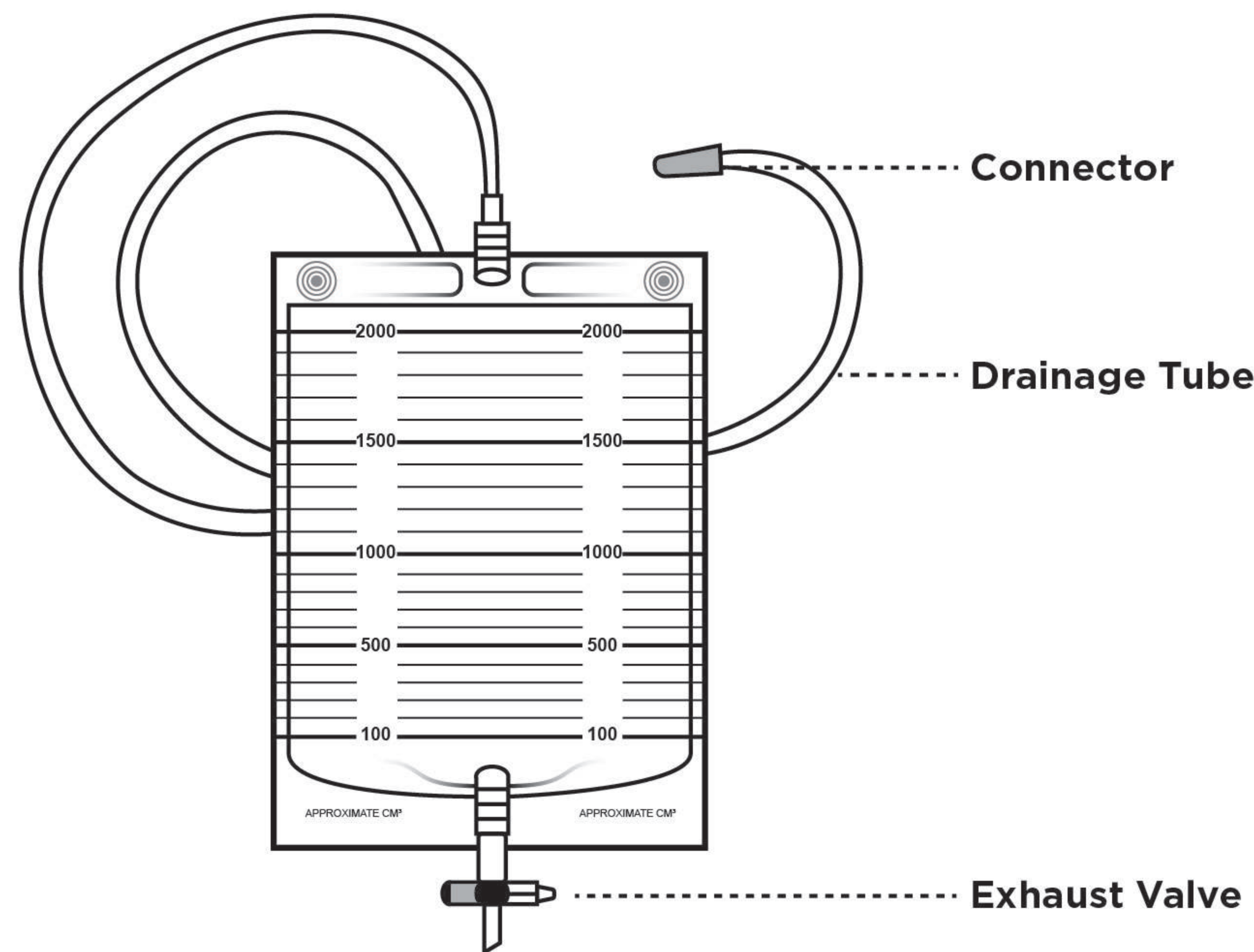
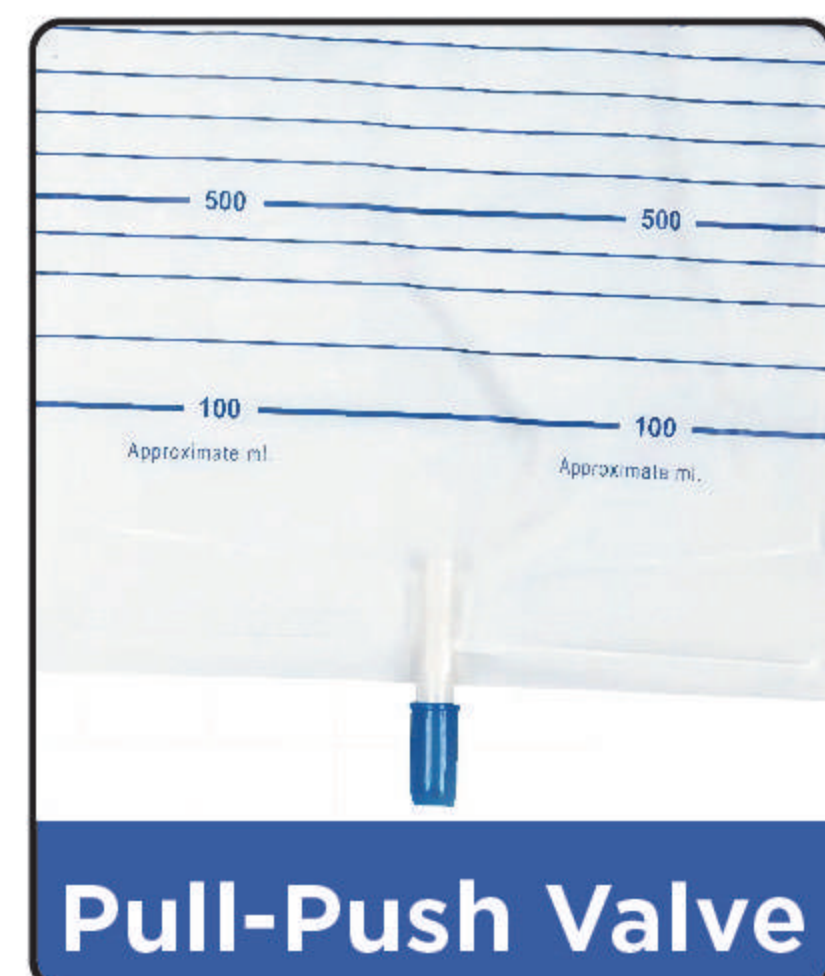

- Anti-reflux valve prevent urine reflux
- Enough urinary canal to guarantee the unimpeded flow
- Clearly marked graduations for self-management

Model	Without Valve, Pull-Push Valve, T-Valve
Size	2000ml, 27.5cm x 20cm
Material	PVC
Shelf Life	5 Years
Packing Specification	10 pcs/pack, 25 packs/ctn 40cm x 36cm x 30cm; 40cm x 36cm x 32cm; 40cm x 36cm x 37cm

Umbilical Cord Clamp

[Code No.] HL012



- Be used with scissors
- Steriled
- For single use
- Individually packed
- For clamping the umbilical cord of newborn babies
- Designed with smooth edges to prevent any harm or discomfort

Size	50 mm
Material	PE
Shelf Life	5 Years
Type of Sterilization	EO
Packing Specification	100 pcs/box, 50 boxes/ctn; 52cm x 36cm x 42cm

URINE BAG

UMBILICAL CORD CLAMP

Accessories

[Code No.] HL013 **Heparin Cap**

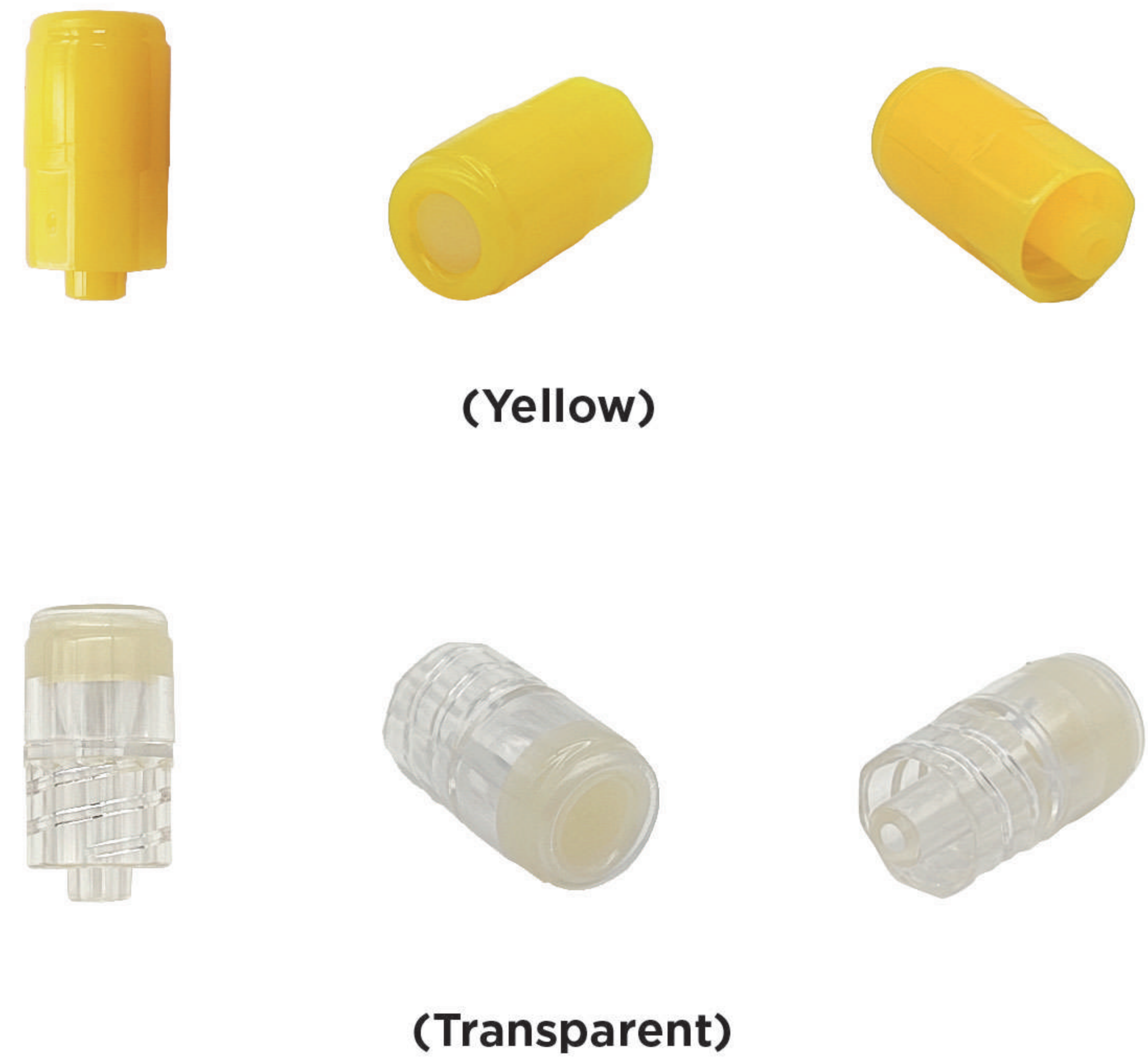

- Sterile, individually packed
- Be used as injection way and injection port
- Heparin to prevent blood clotting and reflux

Model	Yellow, Transparent
Material	PC
Shelf Life	5 Years
Type of Sterilization	EO
Packing Specification	100 pcs/box, 50 boxes/ctn; 45cm x 42cm x 28cm

Accessories

[Code No.] HL014 **Three Way Stopcock**

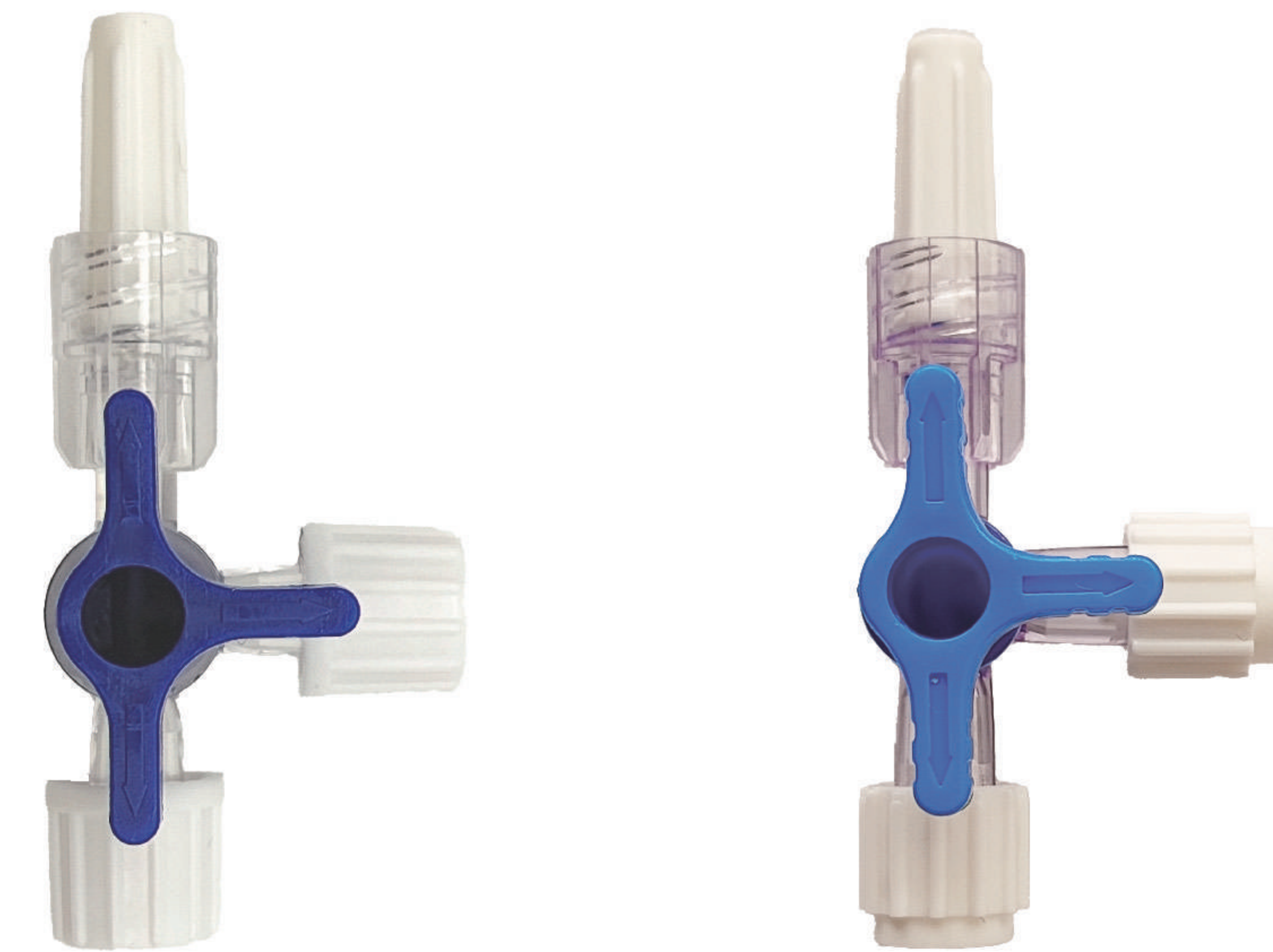

- Sterile, individually packed
- 2 female luer lock, 1 male luer lock rotative
- Rotary adjusting switch to control the flow of liquid

Model	Dark Blue, Light Blue
Material	PC, PE
Shelf Life	5 Years
Type of Sterilization	EO
Packing Specification	50 pcs/box, 20 boxes/ctn; 55cm x 27.5cm x 46cm